



Electrohydraulic actuators for valves

with a 40 mm stroke

SKC32..
SKC82..
SKC62..
SKC60

- SKC32.. Operating voltage AC 230 V, 3-position control signal
- SKC82.. Operating voltage AC 24 V, 3-position control signal
- SKC6.. Operating voltage AC 24 V, control signal DC 0...10 V, 4...20 mA or 0...1000 Ω
- SKC6.. Choice of flow characteristic, position feedback, stroke calibration, LED status indication, override control
- SKC62UA with functions choice of direction of operation, stroke limit control, sequence control with adjustable start point and operating range, operation of frost protection monitors QAF21.. and QAF61..
- Positioning force 2800 N
- Actuator versions with or without spring-return function
- For direct mounting on valves; no adjustments required
- Manual adjuster and position indicator
- Optional functions with auxiliary switches, potentiometer and stem heater
- SKC..U are UL-approved

Use

For the operation of Siemens 2-port and 3-port valves, types VVF.. and VXF.. with a 40 mm stroke as control and safety shut-off valves in heating, ventilation and air conditioning systems.

Types

	Type	Operating voltage	Positioning signal	Spring-return		Positioning time		Comment		
				Function	Time	Opening	Closing			
Standard electronics	SKC32.60 ¹⁾	AC 230 V	3-position			120 s	120 s			
	SKC32.61 ¹⁾			yes	18 s					
	SKC82.60 ¹⁾	AC 24 V							120 s	20 s
	SKC82.60U ²⁾									
	SKC82.61 ¹⁾			yes	18 s					
	SKC82.61U ²⁾									
		DC 0...10 V, 4...20 mA, or	yes	20 s						
Enhanced electronics	SKC62UA ²⁾		0...1000 Ω	yes	20 s		yes ³⁾			

¹⁾ Approbation: CE

²⁾ Approbation: CE, UL

³⁾ Extra functions. Direction of operation, stroke limit control, sequence control, signal addition

Accessories

Type	Description	For actuator	Mounting location
ASC1.6	Auxiliary switch	SKC6..	1 x ASC 1.6
ASC9.3	Dual auxiliary switches	SKC32..	1 x ASC9.3 and
ASZ7.3	Potentiometer 1000 Ω	SKC82..	1 x ASZ7.3
ASZ6.6	Stem heater AC 24 V	SKC..	1 x ASZ6.6

Ordering

When ordering please specify the quantity, product name and type code.

Example: **1 actuator, type SKC32.60** and

1 potentiometer, type ASZ7.3 and

1 Dual auxiliary switches ASC9.3

Delivery

The actuator, valve and accessories are supplied in separate packaging and not assembled prior to delivery.

Spare parts

See overview, section «Replacement parts», page 20.

Equipment combinations

Valve type	DN	PN-class	k_{vs} [m³/h]	data sheet
Two-port valves VV... (control valves or safety shut-off valves):				
VVF21... ¹⁾ Flange	100	6	124...160	4310
VVF22... Flange	100	6	160	4401
VVF31... ¹⁾ Flange	100...150	10	124...315	4320
VVF32... Flange	100...150	10	160...400	4402
VVF40... ¹⁾ Flange	100...150	16	124...315	4330
VVF42... Flange	100...150	16	125...400	4403
VVF41... ¹⁾ Flange	65...150	16	49...300	4340
VVF45.. Flange	65...150	16	49...300	4345
VVF43.. Flange	65...150	16	50...400	4404
VVF53.. Flange	65...150	25	63...400	4405
VVF61... Flange	65...150	40	49...300	4382
Three-port valves VX... (control valves for «mixing» and «diverting»):				
VXF21... ¹⁾ Flange	100	6	124...160	4410
VXF22... Flange	100	6	160	4401
VXF31... ¹⁾ Flange	100...150	10	124...315	4420
VXF32... Flange	100...150	16	160...400	4402
VXF40... ¹⁾ Flange	100...150	16	124...315	4430
VXF42... Flange	100...150	16	125...400	4403
VXF41... ¹⁾ Flange	65...150	16	49...300	4440
VXF43.. Flange	65...150	16	63...400	4404
VXF53.. Flange	65...150	25	63...400	4405
VXF61... Flange	65...150	40	49...300	4482

For admissible differential pressures Δp_{max} and closing pressures Δp_s , refer to the relevant valve data sheets.

¹⁾ Valves are phased-out

Note Third-party valves with strokes between 12...40 mm can be motorized, provided they are «closed with the de-energized» fail-safe mechanism and provided that the necessary mechanical coupling is available. For SKC32.. and SKC82.. actuators the Y1 signal must be routed via an additional freely-adjustable end switch (ASC9.3) to limit the stroke.

We recommend that you contact your local Siemens office for the necessary information.

Rev. no. Overview table, see page 20.

Technology

Principle of electro-hydraulic actuators

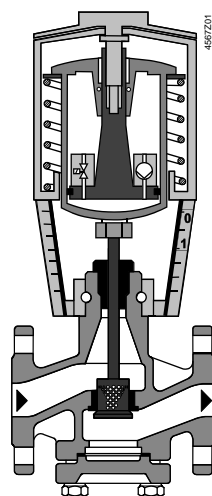

Valve closed

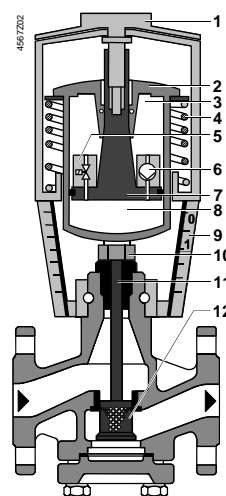

Valve open

- 1 Manual adjuster
- 2 Pressure cylinder
- 3 Suction chamber
- 4 Return spring
- 5 Solenoid valve
- 6 Hydraulic pump
- 7 Piston
- 8 Pressure chamber
- 9 Position indicator (0 to 1)
- 10 Coupling
- 11 Valve stem
- 12 Plug



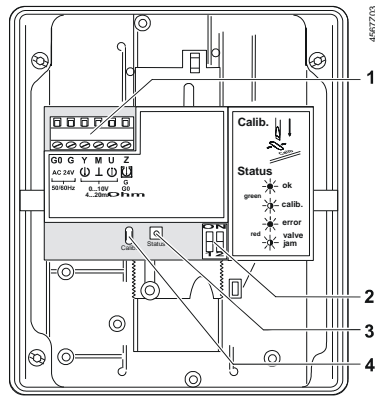

Opening the valve	The hydraulic pump (6) forces oil from the suction chamber (3) to the pressure chamber (8) and thereby moving the pressure cylinder (2) downwards. The valve stem (11) retracts and the valve opens. Simultaneously the return spring (4) is compressed.												
Closing the valve	Activating the solenoid valve (5) allows the oil in the pressure chamber to flow back into the suction chamber. The compressed return spring moves the pressure cylinder upwards. The valve stem extends and the valve closes												
Manual operation mode	<p>For manual operation, swing out the crank so that the display window becomes visible. By rotating the crank or the manual adjustment knob, the display window shows the engagement bar and/or the scale dial with stroke indication.</p> <p>Turning the manual adjuster (1) clockwise moves the pressure cylinder downwards and opens the valve. Simultaneously the return spring is compressed.</p> <p>In the manual operation mode the control signals Y and Z can further open the valve but cannot move to the «0%» stroke position of the valve. To retain the manually set position, switch off the power supply or disconnect the control signals Y and Z. In the display window the red indicator dial is visible.</p>												
Note: Controller in manual operation	When setting the controller for a longer time period to manual operation, we recommend adjusting the actuator with the manual adjuster to the desired position. This guarantees that the actuator remains in this position for that time period. Attention: Do not forget to switch back to automatic operation after the controller is set back to automatic control.												
Automatic mode	Turn the manual adjuster counterclockwise to the end stop. The pressure cylinder moves upward to the «0%» stroke position of the valve. In the display window the red scale disappears and the crank can be swing closed.												
Minimal volumetric flow	The actuator can manually be adjusted to a stroke position > 0 % allowing its use in applications requiring constantly a minimal volumetric flow.												
Spring-return facility	The SKC32.61, SKC82.61.. and SKC62.. actuators, which feature a spring-return function, incorporate a solenoid valve which opens if the control signal or power fails. The return spring causes the actuator to move to the «0 %» stroke position and closes the valve.												
SKC32../SKC82.. 3-position control signal	<p>The actuator is controlled by a 3-position signal either via terminals Y1 or Y2 and generates the desired stroke by means of above described principle of operation.</p> <table border="0"> <tr> <td>• Voltage on Y1</td> <td>piston extends</td> <td>valve opens</td> </tr> <tr> <td>• Voltage on Y2</td> <td>piston retracts</td> <td>valve closes</td> </tr> <tr> <td>• No voltage on Y1 and Y2</td> <td colspan="2">piston / valve stem remain in the respective position</td> </tr> </table>	• Voltage on Y1	piston extends	valve opens	• Voltage on Y2	piston retracts	valve closes	• No voltage on Y1 and Y2	piston / valve stem remain in the respective position				
• Voltage on Y1	piston extends	valve opens											
• Voltage on Y2	piston retracts	valve closes											
• No voltage on Y1 and Y2	piston / valve stem remain in the respective position												
SKC62.., SKC60 Y control signal DC 0...10 V and/or DC 4...20 mA, 0...1000 Ω	<p>The valve is either controlled via terminal Y or override control Z. The positioning signal Y generates the desired stroke by means of above described principle of operation.</p> <table border="0"> <tr> <td>• Signal Y increasing:</td> <td>piston extends</td> <td>valve opens</td> </tr> <tr> <td>• Signal Y decreasing:</td> <td>piston retracts</td> <td>valve closes</td> </tr> <tr> <td>• Signal Y constant:</td> <td colspan="2">piston / valve stem remain in the respective position</td> </tr> <tr> <td>• Override control Z</td> <td colspan="2">see description of override control input, page 8</td> </tr> </table>	• Signal Y increasing:	piston extends	valve opens	• Signal Y decreasing:	piston retracts	valve closes	• Signal Y constant:	piston / valve stem remain in the respective position		• Override control Z	see description of override control input, page 8	
• Signal Y increasing:	piston extends	valve opens											
• Signal Y decreasing:	piston retracts	valve closes											
• Signal Y constant:	piston / valve stem remain in the respective position												
• Override control Z	see description of override control input, page 8												
Frost protection monitor Frost protection thermostat	A frost protection thermostat can be connected to the SKC6.. actuator. The added signals from the QAF21.. and QAF61.. require the use of SKC62UA actuators. Notes on special programming of the electronics are described under «Enhanced electronics» on page 5 «Connection diagrams» for operation with frost protection thermostat or frost protection monitor refer to page 16.												

Standard electronics
SKC62..., SKC60



- 1 Connection terminals
- 2 Mode DIL switches
- 3 LED status indication
- 4 Slot for calibration

DIL switches
SKC62..., SKC60

	Positioning signal Y Position feedback U	Flow characteristic
ON	 DC 4...20 mA	 lin = linear
OFF *)	 DC 0...10 V	 log = equal percentage

*) Factory setting:
All switches OFF

Relationship
between control
signal Y and
volumetric flow

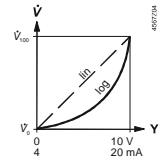



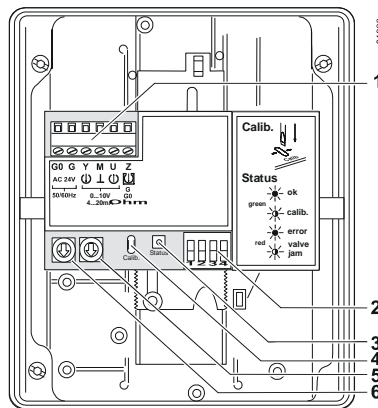





Enhanced electronics
SKC62UA



- 1 Connection terminals
- 2 DIL switches
- 3 LED status indication
- 4 Stroke calibration
- 5 Rotary switch **Up**
(factory setting 0)
- 6 Rotary switch **Lo**

DIL switches
SKC62UA

	Direction of operation	Sequence control or stroke limit control	Control signal Y Position feedback U	Flow characteristic
ON	 reverse-acting	 Sequence control Signal addition QAF21../QAF61..	 DC 4...20 mA	 lin = linear
OFF *	 direct-acting	 Stroke limit control	 DC 0...10 V	 log = equal percentage

* Factory settings: all switches
OFF

Relationship
between control
signal Y and
volumetric flow

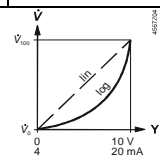

Selection of direction of operation
SKC62UA

- With normally-closed valves, «direct-acting» means that with a signal input of 0 V, the valve closes (applies to all Siemens valves listed under «equipment combinations» on page 3)
- With normally-open valves, «direct-acting» means that with a signal input of 0 V, the valve is open.

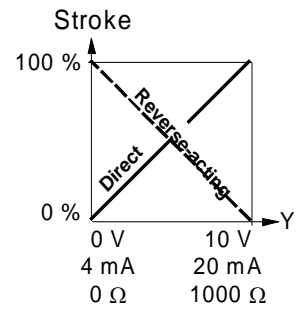
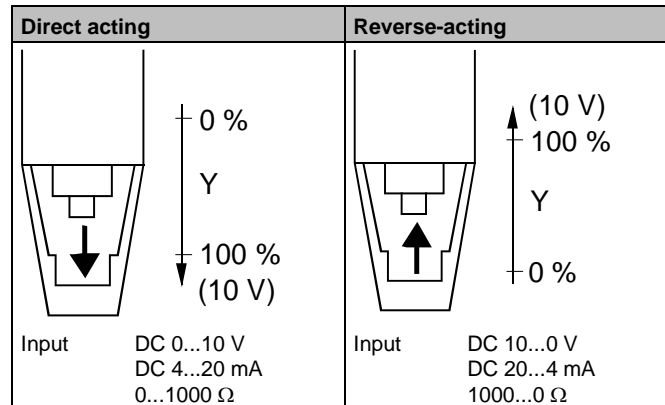

Note The mechanical spring-return function is not affected by the direction of operation selected.

Stroke limit control
and sequence control
SKC62UA

Setting the stroke limit control

The rotary switches LO and UP can be used to apply an upper and lower limit to the stroke in increments of 3%, up to a maximum of 45%

Position of LO	Lower stroke limit	Position of UP	Upper stroke limit
0	0 %	0	100 %
1	3 %	1	97 %
2	6 %	2	94 %
3	9 %	3	91 %
4	12 %	4	88 %
5	15 %	5	85 %
6	18 %	6	82 %
7	21 %	7	79 %
8	24 %	8	76 %
9	27 %	9	73 %
A	30 %	A	70 %
B	33 %	B	67 %
C	36 %	C	64 %
D	39 %	D	61 %
E	42 %	E	58 %
F	45 %	F	55 %

Setting the sequence control

The rotary switches LO and UP can be used to determine the starting point or the operating range of a sequence.

Position of LO	Starting point for sequence control	Position of UP	Operating range of sequence control
0	0 V	0	10 V
1	1 V	1	10 V *
2	2 V	2	10 V **
3	3 V	3	3 V ***
4	4 V	4	4 V
5	5 V	5	5 V
6	6 V	6	6 V
7	7 V	7	7 V
8	8 V	8	8 V
9	9 V	9	9 V
A	10 V	A	10 V
B	11 V	B	11 V
C	12 V	C	12 V
D	13 V	D	13 V
E	14 V	E	14 V
F	15 V	F	15 V

- * Operating range of QAF21.. (see below)
- ** Operating range of QAF61.. (see below)
- *** The smallest adjustment is 3 V; control with 0...30 V is only possible via Y.

Stroke control with
QAF21.. / QAF61..
signal addition
SKC62UA only

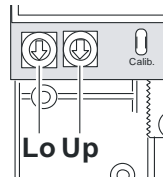

Setting the signal addition

The operating range of the frost protection monitor (QAF21.. or QAF61..) can be defined with rotary switches LO and UP.

Position of LO	Sequence control start point	Position of UP	QAF21../ QAF61.. operating range
0		1	QAF21..
0		2	QAF61..

Calibration
SKC62.., SKC60

In order to determine the stroke positions 0 % and 100 % in the valve, calibration is required on initial commissioning:

Prerequisites

- Mechanical coupling of the actuator SKC6.. with a Siemens valve
- **Actuator must be in «Automatic operation» enabling stroke calibration to capture the effective 0 % and 100 % values**
- AC 24 V power supply
- Housing cover removed

Calibration

1. Short-circuit contacts in calibration slot (e.g. with a screwdriver)
2. Actuator moves to «0 %» stroke position (1) (valve closed)
3. Actuator moves to «100 %» stroke position (2) (valve open)
4. Measured values are stored

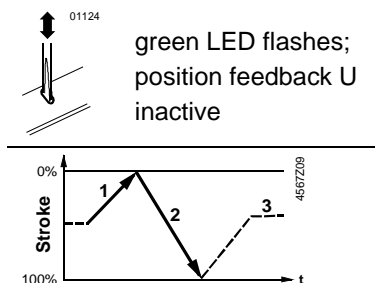





Normal operation

- | | |
|--|---|
| 5. Actuator moves to the position (3) as indicated by signals Y or Z | green LED is lit permanently; position feedback U active, the values correspond to the actual positions |
|--|---|

A lit red LED indicates a calibration error.
The calibration can be repeated any number of times.

Indication of operating state
SKC62..., SKC60





The LED status indication indicates operational status with dual-colored LED and is visible with removed cover.

LED	Indication	Function	Remarks, troubleshooting
Green	Lit 	Normal operation	Automatic operation; everything o.k.
	Flashing 	Calibration in progress	Wait until calibration is finished (LED stops flashing, green or red LED will be lit)
Red	Lit 	Faulty stroke calibration	Check mounting Restart stroke calibration (by short-circuiting calibration slot)
	Flashing 	Internal error Inner valve jammed	Replace electronics Check valve
Both	Dark 	No power supply Electronics faulty	Check mains network, check wiring Replace electronics

As a general rule, the LED can assume only the states shown above (continuously red or green, flashing red or green, or off).

Override control input Z
SKC62..., SKC60

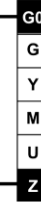
Override control input can be operated in following different modes of operation

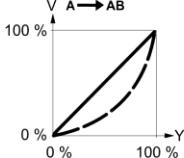
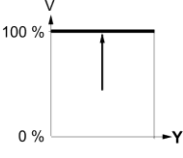
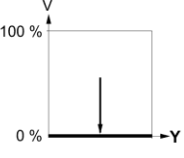
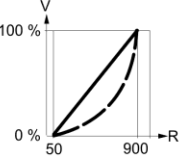
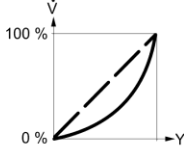
		Z-mode				
		no function	fully open	closed	override with 0...1000 Ω	Signal addition SKC62UA only
Connections						
	Transfer					
		linear or equal-percentage			linear or equal-percentage	linear or equal-percentage
		<ul style="list-style-type: none"> Z-contact not connected Valve stroke follows Y-input 	<ul style="list-style-type: none"> Z-contact connected directly to G Y-input has no effect 	<ul style="list-style-type: none"> Z-contact connected directly to G0 Y-input has no effect 	<ul style="list-style-type: none"> Z-contact connected to M via resistor R Starting position at 50 Ω / end position at 900 Ω Y-input has no effect 	<ul style="list-style-type: none"> Z-contact is connected to R of the frost protection monitor QAF21.. or QAF61.. Valve stroke follows signals Y and R(Z)

Note Shown operation modes are based on the factory setting «direct acting»
Y-input has no effect in Z-mode.

SKC..

ASZ6.6
stem heater

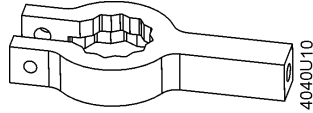

- for media below 0 °C
- mount between valve and actuator

SKC32.., SKC82..

ASC9.3
double auxiliary switch

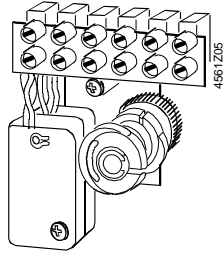

adjustable switching points

ASZ7.3
potentiometer

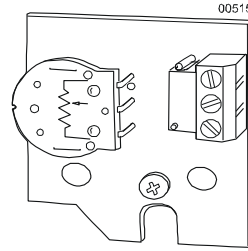

0...1000 Ω

Note: ASZ7.3

For the combination SIMATIC S5/S7 and position feedback message, we recommend actuators with DC 0...9.8 V feedback signals.

The signal peaks that occur in the potentiometer ASZ7.3 may result in error messages on Siemens SIMATIC.

This is not the case when combined with Siemens HVAC controllers.

The reason is that SIMATIC has a higher resolution and faster response time.

SKC62.., SKC60

ASC1.6
auxiliary switch

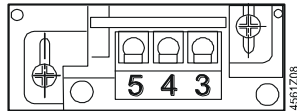

switching point 0...5 % stroke

See section «Technical data» on page 13 for more information.

Conduct the electrical connections in accordance with local regulations on electrical installations as well as the internal or connection diagrams.

Caution 

Safety regulations and restrictions designed to ensure the safety of people and property must be observed at all times!



The plant operator must also ensure compliance with applicable guidelines on cable insulation when using a safety limiter. Failure to comply may cause the safety limiter function to fail.

Caution 

For media below 0 °C the ASZ6.6 stem heater is required to keep the valve from freezing. For safety reasons the stem heater is designed for an operating voltage of AC 24 V / 30 W.

For this case, do not insulate the actuator bracket and the valve stem, as air circulation must be ensured. Do not touch the hot parts without prior protective measures to avoid burns.

Non-observance of the above may result in accidents and fires!

Recommendation: Above 140 °C insulating the valves is strictly recommended.

Observe admissible temperatures, refer to «Use» on page 2 and «Technical data» on page 13.

If an auxiliary switch is required, its switching point should be indicated on the plant schematic.

Every actuator must be driven by a dedicated controller (refer to «Connection diagrams», page 16).

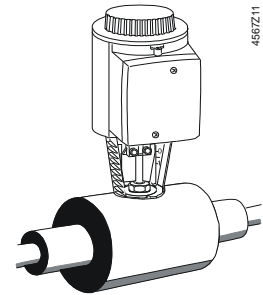

Mounting instructions

Mounting Instruction 74 319 0324 0 for fitting the actuator to the valve are by packed in the actuator packaging. The instructions for accessories are enclosed with the accessories themselves.

Accessories	Installation instructions	Accessories	Mounting instructions		
ASC1.6	G4563.3	4 319 5544 0	ASZ7.3	74 319 0247 0	
ASC9.3	G4561.3	4 319 5545 0	ACT control unit	M4568	74 319 0554 0
SKC..	M3240	74 319 0324 0	QAF21..		74 319 0399 0
SKC..		74 319 0326 0	ASZ6.6	M4501.1	74 319 0750 0

Orientation

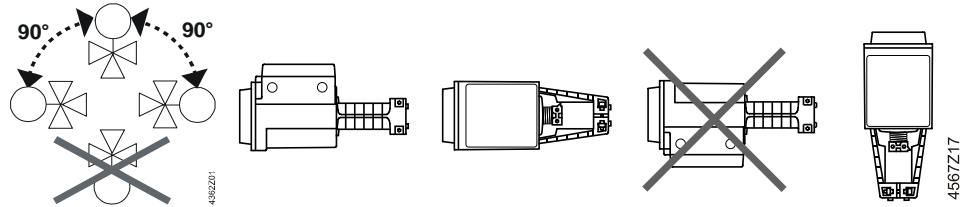

Commissioning notes

When commissioning the system, check the wiring and functions, and set any auxiliary switches and potentiometers as necessary, or check the existing settings.

Cylinder with valve stem connector fully retracted
→ stroke = 0%

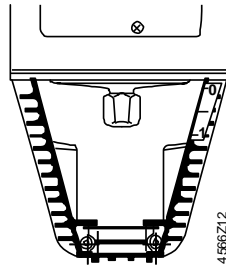

Cylinder with valve stem connector fully extended
→ stroke = 100%

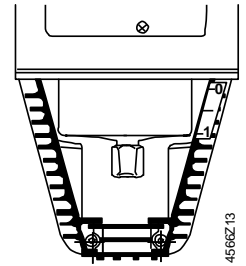

The manual adjuster must be rotated counterclockwise to the end stop. This causes the Siemens valves, types VVF.. and VXF.. to close (stroke = 0 %).

Automatic operation

For automatic operation, the crank (2) on the manual adjustment knob (1) must be engaged. If not engaged, turn the crank counter-clockwise until the display window (3) neither shows the scale (4) nor the crank engagement bar.

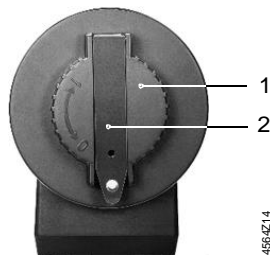

Engaged crank (2) on the manual adjustment knob (1)

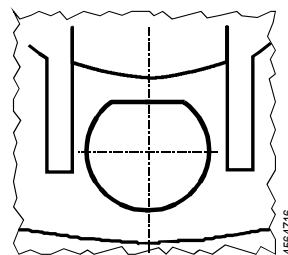

Display window with invisible scale dial and crank engagement bar

Manual operation

For manual operation, swing out the crank (2) so that the display window (3) becomes visible. By rotating the crank or the manual adjustment knob (1), the display window shows the engagement bar and/or the scale dial with stroke indication.

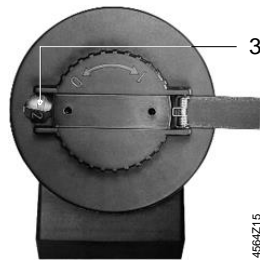

Swung-out crank,
display window (3)

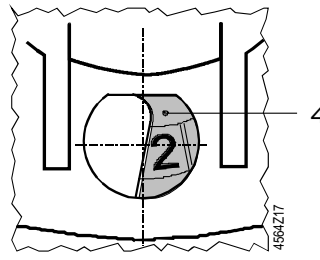

Display window with scale dial (4) and stroke
indication

Maintenance notes

The SKC.. actuators are maintenance-free.



When servicing the actuator:

- **Switch off pump of the hydronic loop**
- **Interrupt the power supply to the actuator**
- **Close the main shutoff valves in the system**
- **Release pressure in the pipes and allow them to cool down completely**
- **If necessary, disconnect electrical connections from the terminals**
- **The actuator must be correctly fitted to the valve before recommissioning.**

Repair

Recommendation SKC6...: trigger stroke calibration.

«Replacement parts», see page 20.



A damaged housing or cover represents an injury risk

- **NEVER uninstall an actuator from the valve**
- **Uninstall the valve-actuator combination (actuating device) as a complete device**
- **Use only properly trained technicians to uninstall the unit**
- **Send the actuating device together with an error report to your local Siemens representative for analysis and disposal**
- **Properly mount the new actuating device (valve and actuator)**

Parts could fly ultimately resulting in injuries from uninstalling an actuator with a damaged valve housing due to the tensioned return spring.

Disposal



The device is considered an electronics device for disposal in terms of European Directive 2012/19/EU and may not be disposed of as domestic garbage.

- Dispose of the device through channels provided for this purpose.
- Comply with all local and currently applicable laws and regulations.

Warranty

Technical data on specific applications are valid only together with Siemens products listed under "Equipment combinations", page 3. Siemens rejects any and all warranties in the event that third-party products are used.

Technical data

		SKC32..	SKC82..	SKC6..
Power supply	Operating voltage	AC 230 V	AC 24 V	AC 24 V
	Voltage tolerance	± 15 %	± 20 %	± 20 %
		SELV / PELV		
	Frequency	50 or 60 Hz		
Max. Power consumption at 50 Hz	SKC32.60:	18 VA / 14 W	SKC82.60, ..60U 15 VA / 12 W	SKC60 17 VA / 13 W
	SKC32.61:	24 VA / 18 W	SKC82.61, ..61U 19 VA / 14 W	SKC62.. 21 VA / 15 W
	External supply cable fuse	min. 0.5 A, slow max. 6 A, slow	min. 1.6 A, slow max. 10 A, slow	
Signal inputs	Control signal	3-position		DC 0...10 V, DC 4...20 mA, 0...1000 Ω
	Terminal Y	Voltage Input impedance Current Input impedance Signal resolution Hysteresis		DC 0...10 V 100 kΩ DC 4...20 mA 240 Ω < 1% 1 %
	Terminal Z Override control	Resistor Z not connected, priority terminal Y Z connected directly to G Z connected directly to G0 Z connected to M via 0...1000 Ω		0...1000 Ω No function max. stroke 100 % min. stroke 0 % stroke proportional to R
Position feedback	Terminal U	voltage load impedance current load impedance		DC 0...9.8 V > 10 kΩ DC 4...19.6 mA < 500 Ω
Connecting cable	Cable cross-sectional area	0.5 ... 2.5 mm ² / AWG 21 ... 14		
Functional Data	Positioning time at 50 Hz ¹⁾	opening	SKC32.6.. 120 s	SKC82.6.. 120 s
		Closing	SKC32.6.. 120 s	SKC82.6.. 120 s
	Spring-return time ¹⁾	SKC32.61 18 s	SKC82.61 18 s	SKC62.. 20 s
	Positioning force	2800 N		
	Nominal stroke	40 mm		
	Max. permissible medium temperature	-25...220 °C < 0 °C: requires stem heater ASZ6.6		
¹⁾ At room temperature (23°C), low ambient temperatures or high Δp may prolong these times				
Electrical connections	Cable entry	4 x M20 (Ø 20,5 mm) with knockouts for standard ½" conduit connectors (Ø 21.5 mm)		
	..U			
Standards, directives and approvals	Product standard	EN 60730-x		
	Electromagnetic compatibility (Applications)	For use in residential, commercial, light-industrial and industrial environments		
	EU conformity (CE)	A5W00007751 ¹⁾		
	RCM-conformity (EMC)	A5W00007895 ¹⁾		
	AC 230 V			
	EAC conformity	Eurasia conformity for all SKC..		
	UL certification: UL, cUL			
	AC 230 V	-		
	AC 24 V	UL 873, http://ul.com/database		

		SKC32..	SKC82..	SKC6..
Environmental compatibility		The product environmental declarations CE1E4566en01 ¹⁾ and CE1E4566en02 ¹⁾ contain data on RoHS compliance, materials composition, packaging, environmental benefit and disposal.		
Dimensions / Weight	Dimensions	refer to «Dimensions», page 19		
	Weight (packing excluded)	SKC32.60 9.80 kg SKC32.61 9.85 kg	SKC82.60 9.80 kg SKC82.60U 10.10 kg SKC82.61 9.85 kg SKC82.61U 10.15 kg	SKC60/62 9.85 kg SKC62U/UA 10.15 kg
Materials	Actuator housing, bracket	Die-cast aluminum		
	Housing box and manual adjuster	Plastic		

¹⁾ The documents can be downloaded from <http://siemens.com/bt/download>.

Accessories		SKC32.., SKC82..	SKC6..
ASC1.6 Auxiliary switch	Switching capacity		AC 24 V, 10 mA...4 A resistive, 2 A inductive
ASC9.3 double auxiliary switch	Switching capacity per auxiliary switch	AC 250 V, 6 A resistive, 2.5 A inductive	
ASZ7.3 Potentiometer	Change in overall resistance of potentiometer at nominal stroke	0...1000 Ω	
ASZ6.6 stem heater	Operating voltage	AC 24 V ± 20 %	
	Power consumption	40 VA / 30 W	
	Inrush current	Max. 8,5 A (max. temperature 85 °C / 185 F)	

SKC62UA enhanced functions

Direction of operation	Direct-acting, reverse-acting	DC 0...10 V / DC 10...0 V DC 4...20 mA / DC 20...4 mA 0...1000 Ω / 1000...0 Ω
Stroke limit control	Range of lower limit	0...45 % adjustable
	Range of upper limit	100...55 % adjustable
Sequence control	Terminal Y	
	Starting point of sequence	0...15 V adjustable
	Operating range of sequence	3...15 V adjustable
Signal addition	Z connected to R of	
	Frost protection monitor QAF21..	0...1000 Ω, added to Y signal
	Frost protection monitor QAF61..	DC 1.6 V, added to Y signal

Ambient conditions and protection data

Classification to IEC/EN 60730	Automatic action: Type 1AA / Type 1AC / Modulation Action
	Pollution degree: 2
Housing protection as per IEC/EN 60529	IP54
Environmental conditions	
Transportation (in transport packaging) to IEC/EN 60721-3-2	Class 2K3 Temperature -30...65 °C Humidity 5...95 % (no condensation)
Operation to IEC/EN 60721-3-3	Class 3K5 Temperature -15...<55 °C Humidity 5...95 % (no condensation)
Storage to IEC/EN 60721-3-1	Class 1K3 Temperature -15...55 °C Humidity 5...95 % (no condensation)

Internal diagrams

SKC32.61

AC 230 V, 3-Position

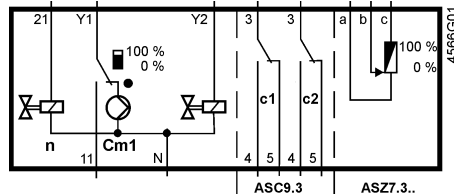

- Cm1** end switch
- n** solenoid valve for spring-return
- c1, c2** ASC9.3 double auxiliary switch
- a, b, c** ASZ7.3 potentiometer
- Y1** Positioning signal «open»
- Y2** Positioning signal «close»
- Z1** spring-return function
- N** neutral conductor

SKC32.60

AC 230 V, 3-Position

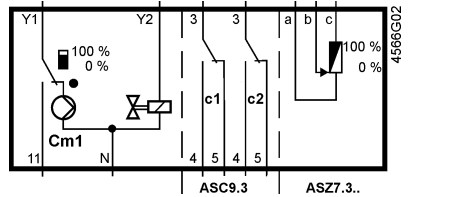

SKC82.61

AC 24 V, 3-Position

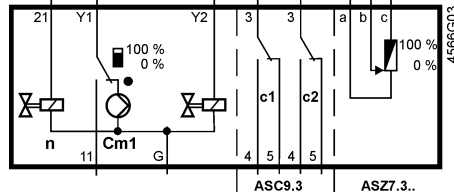

- Cm1** end switch
- n** solenoid valve for spring-return
- c1, c2** ASC9.3 double auxiliary switch
- a, b, c** ASZ7.3 potentiometer
- Y1** Positioning signal «open»
- Y2** Positioning signal «close»
- Z1** spring-return function
- G** System potential

SKC82.60

AC 24 V, 3-Position

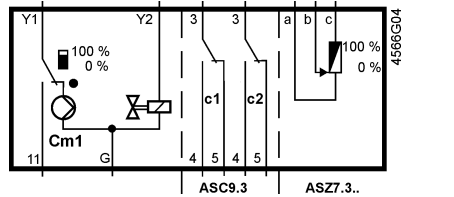

SKC60, SKC62

SKC62U

SKC62UA

AC 24 V, DC 0...10 V, 4...20 mA, 0...1000 Ω

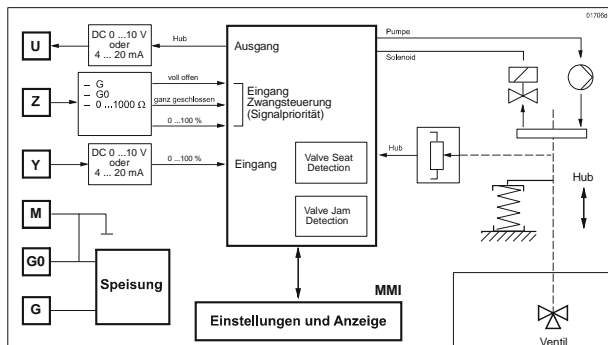

- U** position indication
- Z** override control
- Y** positioning signal
- M** measuring neutral
- G0** operating voltage AC 24 V: system neutral (SN)
- G** operating voltage AC 24 V: system potential (SP)
Switching without power as a spring return function

Connection terminals

SKC6..

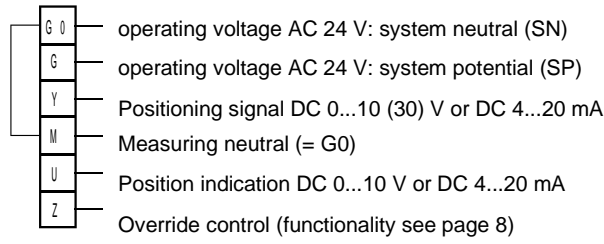

**Auxiliary switch
ASC1.6**

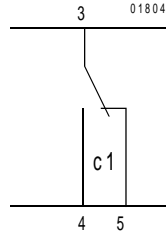

Connection diagrams

**SKC32..
AC 230 V
3-Position**

SKC32.61

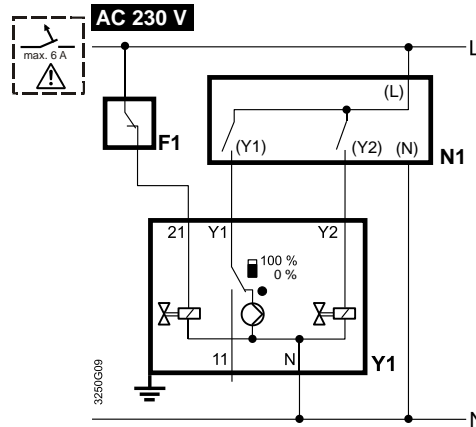

- F1** safety limiter (eg temperature limiter)
- N1, N2** controller
- Y1, Y2** actuators
- L** Phase
- N** neutral

SKC32.60

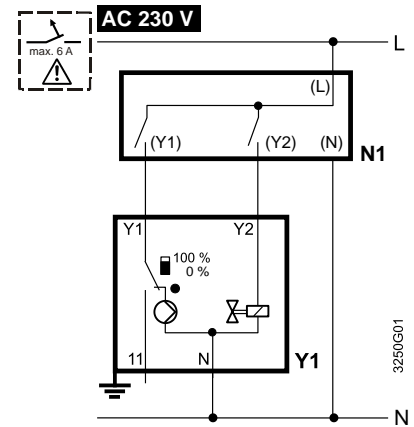

- Y1** Positioning signal «open»
- Y2** Positioning signal «close»
- 21** Spring-return function

SKC82..
AC 24 V
3-Position

SKC82.61, SKC82.61U

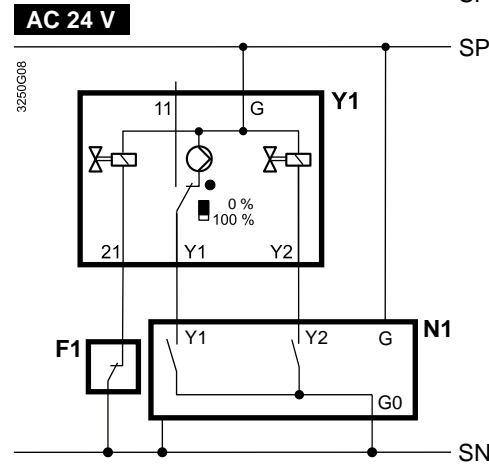
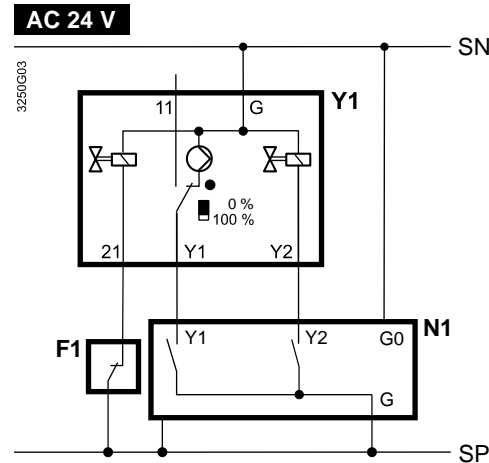

SKC82.60, SKC82.60U

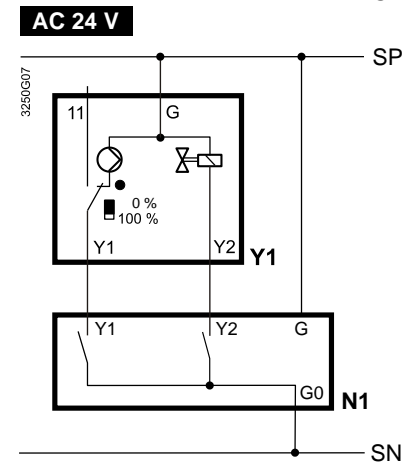
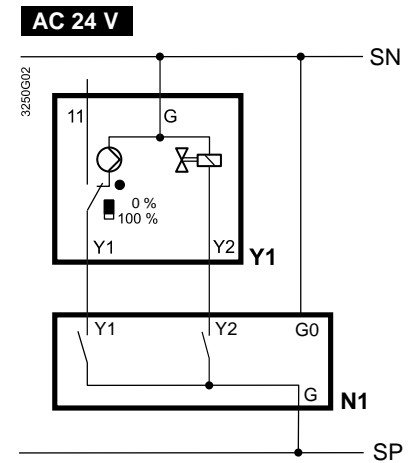

- | | | | | | |
|---------------|---|-----------|-------------------------|-----------|----------------------------|
| F1 | safety limiter (eg temperature limiter) | SP | Systempotential AC 24 V | Y1 | Positioning signal «open» |
| N1, N2 | controller | SN | System neutral | Y2 | Positioning signal «close» |
| Y1, Y2 | actuators | | | Z1 | Spring-return function |

SKC6..
AC 24 V
DC 0...10 V, 4...20 mA,
0...1000 Ω

SKC60

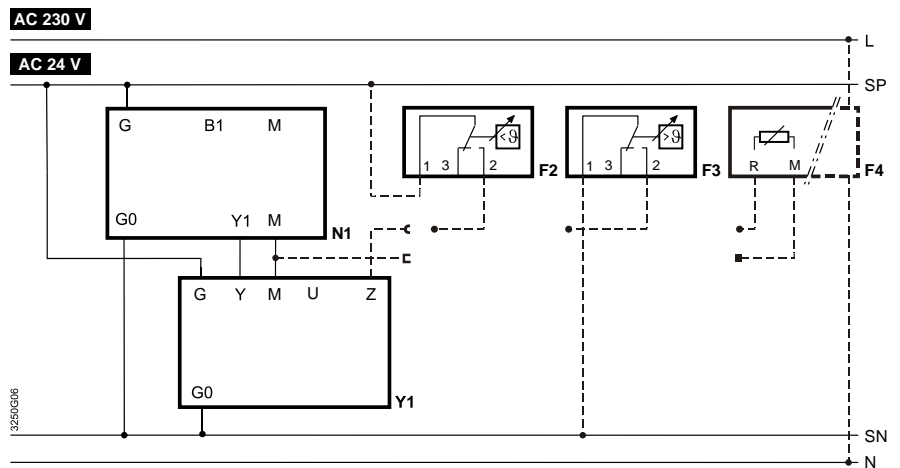

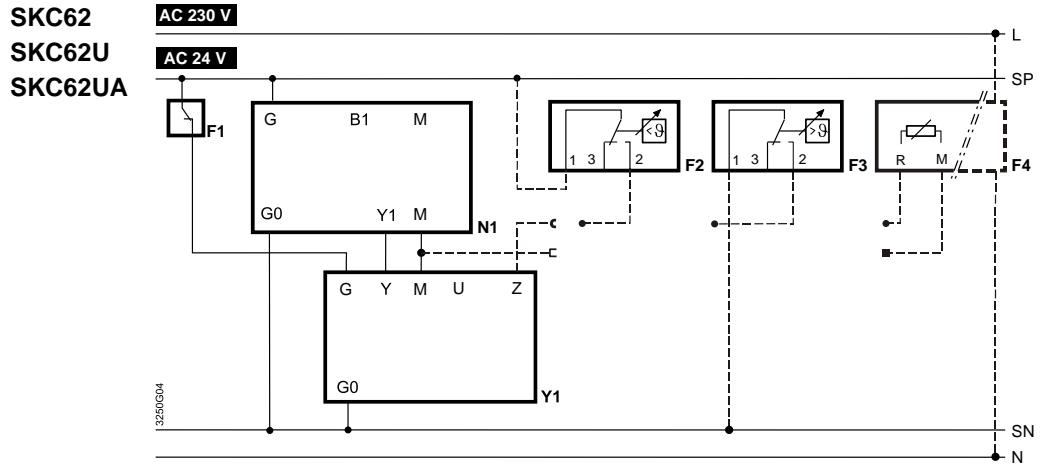

- Y1** actuator
 - N1** controller
 - F1** safety limiter (eg temperature limiter)
 - F2** frost protection thermostat
 - terminals: 1 – 2 frost hazard / sensor is interrupted (thermostat closes with frost)
 - 1 – 3 normal operation
 - F3** temperature detector
 - F4** Frost protection monitor with 0...1000 Ω signal output, e.g. QAF21.. or QAF61.. (only SKB62UA) *
 - G (SP)** System potential AC 24 V
 - G0 (SN)** System neutral
- * Only with sequence control and the appropriate selector switch settings (see page 5ff)



When using the safety limiter F1, ensure that no mistakes may occur on cable insulation that may cancel out the temperature limiter function (applies to both 230 V as well as 24 V types).

For SN earthing (e.g. PELV) comply under all circumstances with the note above.

Dimensions

All dimensions in mm

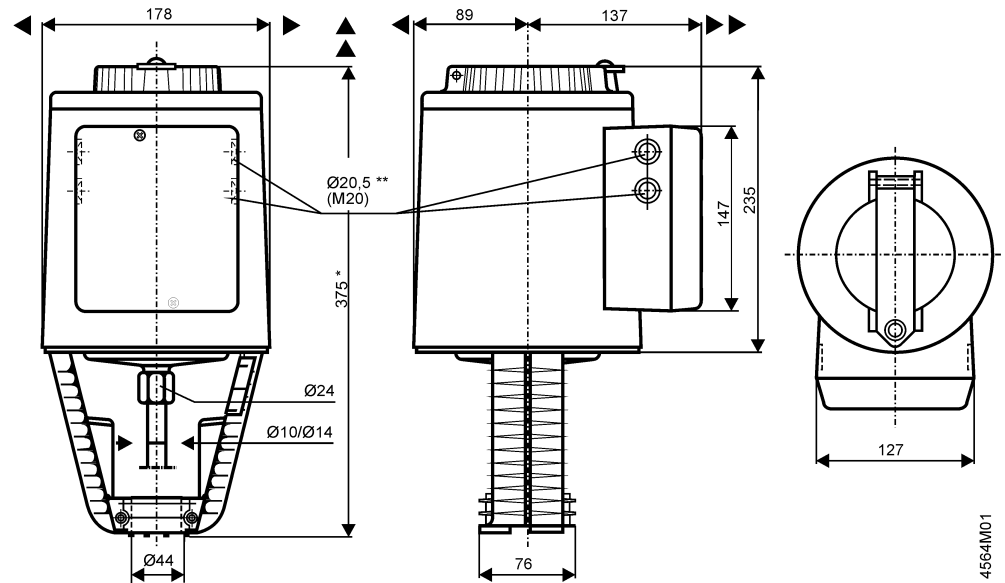





4564M01

** **SKC..U:** with knockouts for standard 1/2" conduit connectors ($\varnothing 21.5$ mm)

- ▶ = > 100 mm, minimum clearance from ceiling or wall for mounting,
- ▶▶ = > 200 mm, connection, operation, maintenance etc.

Replacement parts

Order numbers for replacement parts

Actuator type	Cover	Hand control ¹⁾	Clamp	Stem connection	Control unit
					
SKC32.60	410455828	426855108	410355768	417856498	
SKC32.61	410455828	426855108	410355768	417856498	
SKC82.60	410455828	426855108	410355768	417856498	
SKC82.60U	410455828	426855108	410356058	417856498	
SKC82.61	410455828	426855108	410355768	417856498	
SKC82.61U	410455828	426855108	410356058	417856498	
SKC62	410455828	426855108	410355768	417856498	466857488
SKC62U	410455828	426855108	410356058	417856498	466857488
SKC60	410455828	426855108	410355768	417856498	466857598
SKC62UA	410455828	426855108	410356058	417856498	466857518

1) hand control, blue with mechanical parts

Revision numbers

Type reference	Valid from rev. No.	Type reference	Valid from rev. No.
SKC32.60	..D	SKC82.61U	..D
SKC32.61	..D	SKC62	..G
SKC82.60	..D	SKC62U	..G
SKC82.60U	..D	SKC60	..G
SKC82.61	..D	SKC62UA	..G

Issued by:
Siemens Switzerland Ltd
Smart Infrastructure
Global Headquarters
Theilerstrasse 1a
CH-6300 Zug
+41 58 724-2424

www.siemens.com/buildingtechnologies

© Siemens Switzerland Ltd 2002
Delivery and technical specifications subject to change